



Powerful engines for your security base

M6 True Enterprise NVRs

M6236, M6024, M6016, M6012, M6108, & Extended Storage Servers S6044 & S6024

The True Enterprise is GVD's server-grade NVRs designed for enterprise high-capacity applications. Five models, M6236, M6024, M6016, & M6012, are the heavyweights with redundant hardware (dual power units and dual LAN ports) to allow the extra robustness for enterprise activities, while the other one, M6108, is lighter but equally capable.

For video read/write, the most capable model can 24x7 process video on 256 channels, with a recording rate of up to 512 Mbps, while the lightest one is able to process 64 channels by 288 Mbps.

- 32, 48, 64, 96, 128, or 256 channels on option
- 36, 24, 16, 12, or 8 HDD trays
- Storage servers S6024 (480TB) & S6044 (880TB) on option
- RAID 0, 1, 5, 6, 10, 50, 60 to protect video data
- Redundant hardware for excellent reliability
- 24x7 video recording at max. 512 Mbps

For storage, the True Enterprise can get a boost up to 1600TB by opting for an external storage server. Also on option is an Archive Server to back up video data and also a Failover Server for fault-tolerance.

The whole True Enterprise lineup is designed to expand to GVD's VMS 4.0 Suite, a cloud-based AI video system to control up to 100,000 channels.

If you are looking for a robust NVR for high-capacity and highly available service, look no further than GVD's True Enterprise NVRs.





Product Highlights

■ Backup and Restore

GVD offers two main backup and restore types: Configuration Backup for system settings and Win OS Backup for the operating system. In case of a serious system failure, quick restoration to a stable state is possible with just a few steps.

■ Extra reliable

The True Enterprise sports dual LAN and power redundancy to tolerate faults and prevent data loss. Hardware and software watchdogs are featured. The hardware watchdog monitors system health, including hardware temperature, fan RPM, and others, while the software one keeps his eye on the operation of system services. There is also a hot-swappable PWM cooling fan to auto-switch itself between different speeds to deliver smart system heat dissipation.

■ Time Sector Engine (TSE)

Unlike conventional NVRs with a centralized database, GVD NVR adopts an exclusive TSE (Time Sector Engine) to handle high bandwidth throughput and to deter latency for massive HD video processing, so that it gets superb video display, whether live or playback. The NVR has a max. recording rate of 512Mbps, handles up to 256 IP cameras, and processes video at high speed with 150ms~190ms latency for a D1 resolution with full frame rate display, and the NVR gives you the best real-time PTZ control by this exclusive TSE.



■ High-capacity

Optimized for enterprise applications, the True Enterprise NVR supports high-density HDDs in 4U and features max. 36 hot-swappable 3.5" SAS3/SATA hard disk trays. Stand-alone, the NVR supports max. 256 channels, while stacked up to VMS 4.0, 100,000 channels are supported.

■ Modbus support & TCP message

The NVR supports Modbus, a very popular serial communication protocol widely-used for the connection of industrial electronic devices. Users don't need to invest extra effort and cost to incorporate a 3rd-party system quickly. The NVR also features powerful alarm management that is capable of sending TCP messages to alert security operators. These advantages make the NVR highly eligible for some promising solutions such as Smart Buildings for DCS (distributed control system) and Smart Cities for CAP (common alerting protocol) such as IBM IOC.

■ Solution for a large and complex system

The NVR is designed to join GVD VMS 4.0 Suite, a cloud-based AI video system that is easy-to-grow to overcome any kind of system integration trouble. The 4.0 can grow to include extensive groups of workstations, video walls, NVRs, data servers, storage, 3rd-party systems, and a large number of 100,000 IP cameras.

GVD VMS 4.0 allows mixed storage in the existing NVRs, IP-SAN, camera SD cards, and private/public clouds. This is highly helpful especially for a large-scale project, such as enterprise or government.



Software Features

Self-Diagnostics of System Hardware

The NVR management software, HD NVR Manager, features some hardware health facilities, for example a hardware tree listing all critical hardware with the essential data called out such as chipset temperature, fan speed, fan RPM, CPU temperature, CPU voltage, SSD temperature and so on. When a hardware component goes out of control, the software will launch an alarm to warn you.

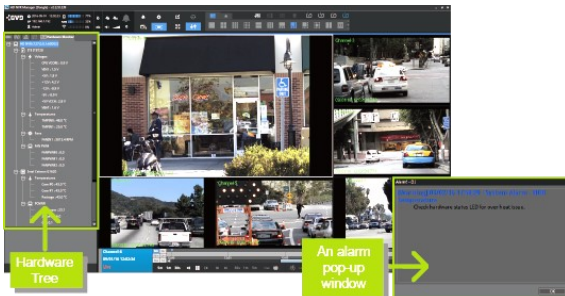

Dynamic video buffer

It is quite often to see the quality of streamed media suffer from network delays. The NVR uses dynamic video buffer size to tolerate poor network conditions, whether with mobile data or WiFi.



N+M Failover for Zero downtime

For mission-critical projects, a Failover Server X5016 is an option for the NVR. The X5016 is a turnkey product to take over a failed NVR within 45 seconds. It has an advanced design to allow non-stop video recording and seamless video display. The failover solution is extra capable with the N+M feature for an X5016 to watch over up to 30 NVRs.

Video Content Analysis

The NVR features sophisticated Video Content Analysis, including VMD (Video Motion Detection) that detects moving objects, E-Fence that discerns objects crossing a virtual line while People Counting calculate how many people have passed a virtual line. Users can set up an interested VCA event for alarms and retrieve the relevant VCA video with a powerful search tool. In some worst cases, VCA can provide you with the evidence for law enforcement.

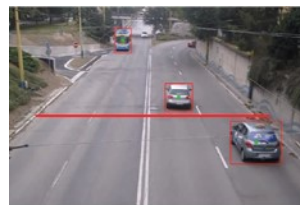

E-Fence

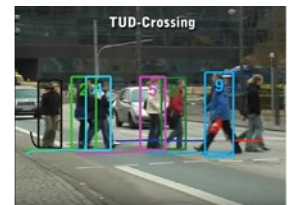

People-Counting

GVD VMS 4.0 Suite

The NVR is designed for GVD's VMS 4.0 Suite, which is capable of controlling 100,000 cameras. This solution also brings cloud, AI, and hybrid storage for the flexible deployment of large video systems. Remote clients are also available, including a PC thin client called VMS Conductor-Lite, IE-App, iOS App, and Android App. Users can access some of the NVR's basic features on these clients on the go, just like they are with the NVR.

System Architecture

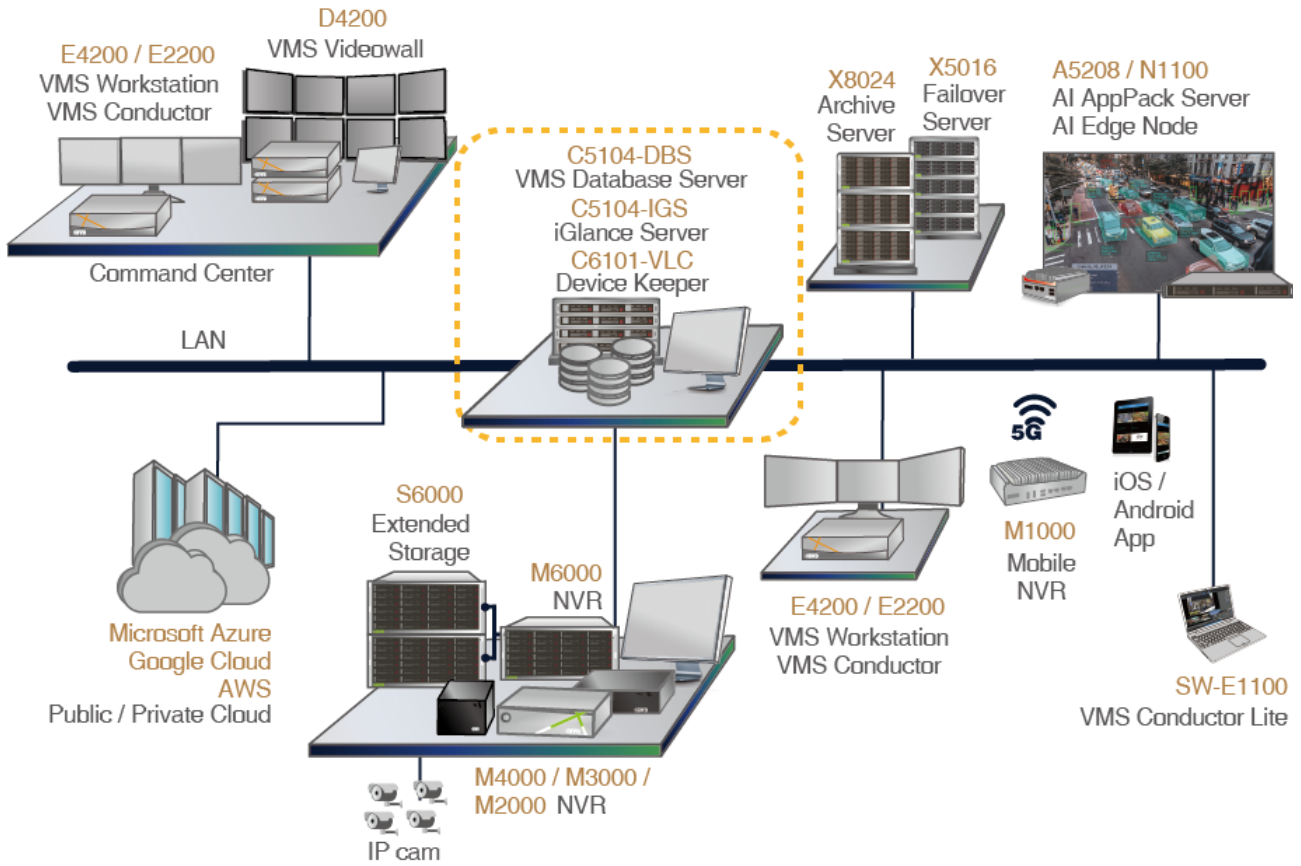

Dimensions

M6108

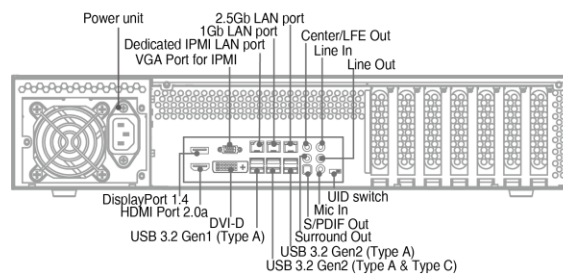
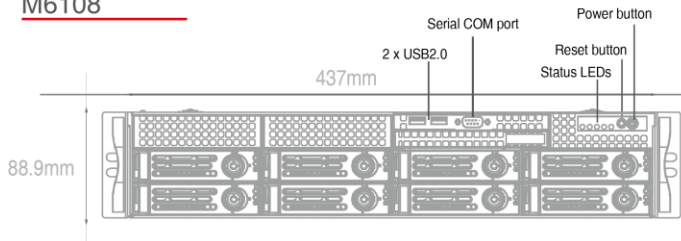

M6012

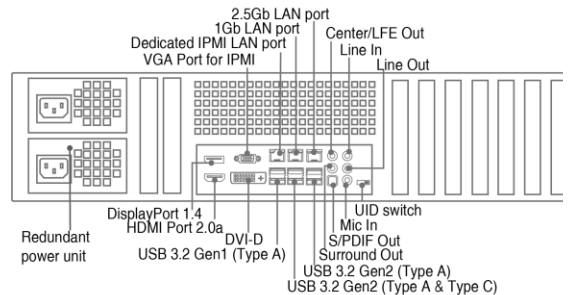
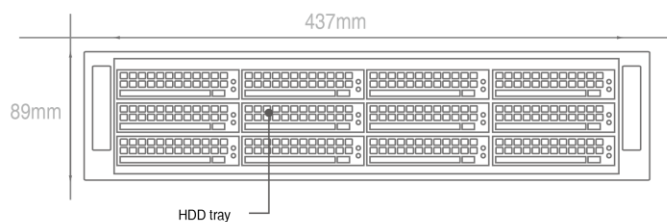

M6016

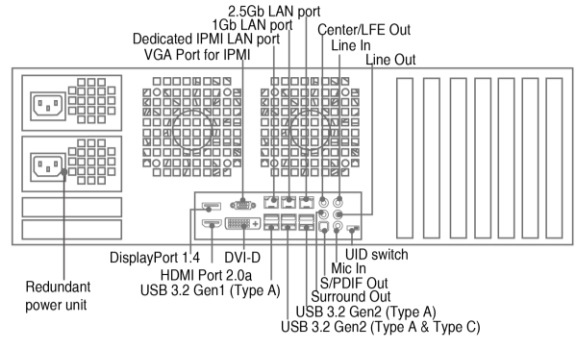
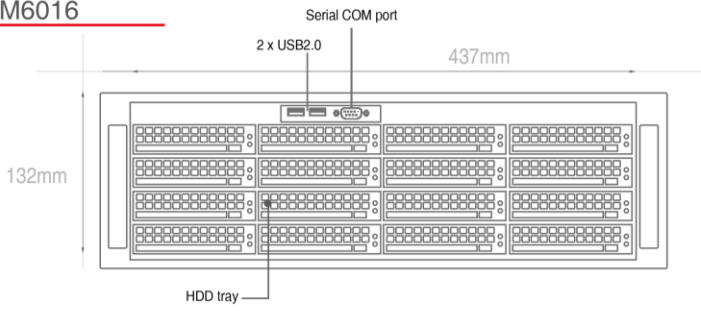

M6H24 & M6024

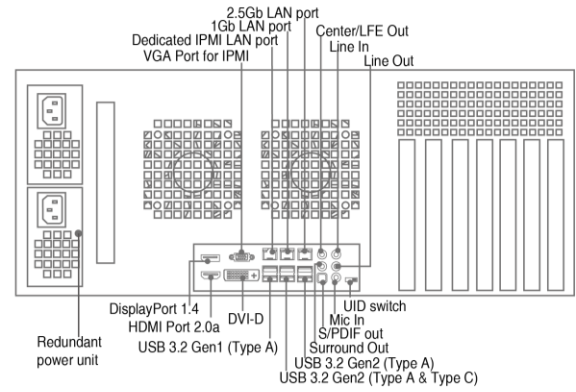
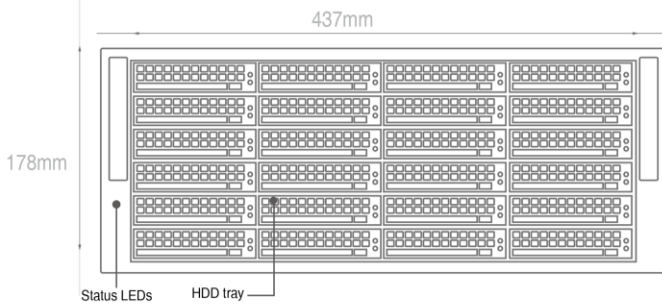

M6236

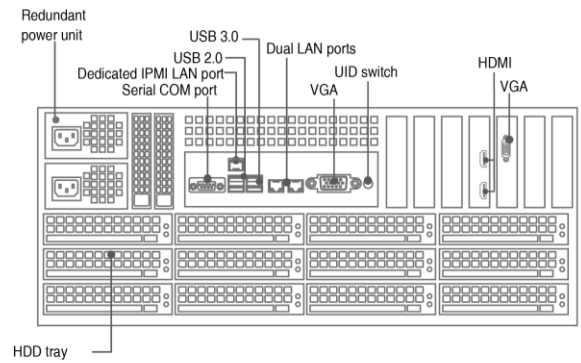
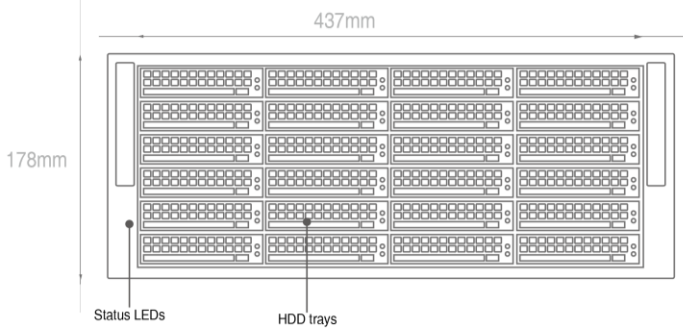

Hardware Specifications



Product	M6236	M6036 <small>EOL</small>	M6H24 <small>EOL</small>	M6024	M6016	M6012	M6108
Description	True Enterprise NVR						
System	CPU	2 x Intel® Xeon® E5 Series, 6 Core	Intel® Xeon® E3-1225 V3	Intel® Xeon® W Series, 6 Core	Intel® 4 Core		Intel® 4 Core
	Memory	32GB		64GB	16GB		
	OS	Windows® 10 IoT Enterprise					
	Watchdog	Hardware watchdog & software watchdog					
Storage	Interface	3.5" SATA HDD					
	Hard disk trays (hotswap)	36 pcs		24 pcs	16 pcs	12 pcs	8 pcs
	Storage capacity	36 x 20TB		24 x 20TB	16 x 20TB	12 x 20TB	8 x 20TB
	RAID level	RAID 0, 1, 5, 6, 10, 50, 60					
Display	Output	1x VGA, 2 x HDMI		1 x DVI-D, 1 x DisplayPort 1.4, 1 x HDMI 2.0a			
	Local disp. resolution	1920 x 1080 Full HD		4096 x 2160 4K Monitor			
Interface	Rear USB port	2 x USB2.0; 2 x USB3.0 (Type A)		2 x USB3.2 Gen1 (Type A); 4 x USB3.2 Gen2 (1 x Type C & 3 x Type A)			
	Front USB port	N/A			2 x USB2.0 (Type A)	N/A	2 x USB2.0 (Type A)
	Audio port	N/A		Rear: 1 x Center/LFE Out, 1 x Surround Out, 1 x S/PDIF Out, 1 x Line In, 1 x Line Out, 1 x Mic In			
	Serial COM port	Rear: 1 x		N/A	Front: 1 x	N/A	Front: 1 x
Network	Interface	2 x Gigabit Ethernet; 1 x Dedicated IPMI		2 x 1Gb LAN			
	Protocols	IPv4, TCP/IP, UDP, HTTP, HTTPS, SMTP, SNMPv2, DNS, DDNS, DHCP, NTP, ARP, ICMP, FTP, RTSP/RTP/RTCP, IGMPv3, UPnP, CIFS, NFS					
Power	Voltage	100~240 Vac, 50-60Hz					
	PSU	1200W	1280W	1200W	1000W	920W	500W
	Redundancy	Yes					No
	Consumption (w/o HDD)	373W	365W	233W	217W	212W	190W
						190W	186W
Environ.	Operating temp.	5°C~35°C (41°F~95°F)					
	Storage temp.	-40°C~70°C (-40°F~158°F)					
	Operating humidity	8%~90%					
	Storage humidity	5%~95%					
Mechanic	Chassis	4U rackmount			3U rackmount	2U rackmount	
	Certification	CE & FCC		CE, FCC, BSMI, BIS	CE & FCC		
	Dimensions (W)x(H)x(D) mm	437x178x699		437x178x660	437x132x647	437x89x647	437 x 88.9 x 533.4
	Net weight w/o HDD	43 kg	42 kg	34 kg	32.7 kg	23.5 kg	17 kg

Software Specifications



Software	M6236	M6036 <small>EOL</small>	M6H24 <small>EOL</small>	M6024	M6016	M6012	M6108	
Description	NVR Manager							
Video recording	IP camera license	64, 96, 128	256	64, 96, 128	64, 96	48, 64	32, 48, 64	
	Recording rate	Max. 384Mbps	Max. 512Mbps	Max. 384Mbps		Max. 256Mbps	Max. 288Mbps	
	Recording resolution	D1, 1.3~20 megapixels						
	Recording mode	Full-time recording, manual recording, recording by schedule, event, alarm, video motion detection						
	Video codec	H.265, H.264, MPEG4, M-JPEG, MxPEG						
	Audio codec	G.711, G.726, AAC						
	Streaming type	Unicast & Multicast						
Video display & management	No. of live video streams	80				64		
	Display pattern	1, 2, 3, 4, 5, 6, 8, 9, 12, 13, 16, 18, 24, 25, 36, 48, 64						
	Live-view operation	ROI, ePTZ, corridor mode, software de-warp, digital zoom in/out, onscreen PTZ						
	ONVIF	ONVIF Profile S						
	Synchronous playback	Up to 16ch						
	Playback controls	Forward/backward playback, pause, jump to next/previous frame, go to date, speed controls, go to some time later/ago (0.5/1/5 minutes)						
	Video export	Via USB (*.AVI, *.AVA, & *.MKV supported), digital watermark						
	Video search	By time, alarm, event, missing object, foreign object, E-Fence, people counting, transaction data from POS						
PTZ	Controlling device	Mouse, K205 Keyboard						
	Operation	Direction controls, zoom in/out, preset, patrol						
VCA	Features	E-Fence, video motion detection, people counting, missing/foreign object search						
	Event search	Search for a missing or foreign object; search for an event of people counting, video motion, or E-Fence						
	Trigger source	Video loss, sensor trigger, HDD crash, system crash, abnormal transaction from POS, E-Fence, video motion detection, people counting						
	Reaction	User-definable text message, video pattern popup, e-mail, output alarm signal, trigger recording, PTZ preset						
	Setup	A Rule Wizard for flexible setup						
Alarm	Trigger source	Video loss, sensor trigger, HDD crash, system crash, abnormal transaction from POS, E-Fence, video motion detection, people counting						
	Reaction	User-definable text message, video pattern popup, e-mail, output alarm signal, trigger recording, PTZ preset						
	Setup	A Rule Wizard for flexible setup						
	DI & DO points	48 x DI points; 48 x DO points						
Remote access clients	Web client	IE 9.0, 10.0, 11.0						
	App client	iOS 10 and above; Android 5.0 and above						
	VMS/CMS & PC thin client	VMS(E4200), CMS(SW-E2200-CW03), CMS Lite(E90-Window 8 &10)						
	Number of clients	16						
POS	License	8 units						
	Integration	Integrable with all brands via POS filters						
	Transaction view	Pattern-view with both transaction data and relevant videos						
	Data search/retrieval	Search by time, keyword or price to retrieve transaction data with relevant video						
	POS alarm	Alarm setup by item or value; supporting popup alarm, email alarm, text message alarm, etc.						
System	System update	NVR software update						
	Backup & recovery	Yes, by VHD (virtual hard disk)						
	Event logs	Event logs of system, cameras, users, etc.						
	Languages	20+ languages are supported, including English, Spanish, French, Dutch, Italian, Japanese, Chinese, etc.						

S6044 & S6024

Rackmountable extended storage

GVD Extended Storage Servers S6024 & S6044 have respectively 24 and 44 hard disk trays at its front to add 480TB and 880TB to a True Enterprise NVR. Simply connect an S6044 to an M6236 True Enterprise NVR by the SAS connectors at their rears to boost the storage of the NVR to 1600TB. Together they bring an ideal solution for the large-scale or mission-critical projects that need to be online around the clock. They are your best choice for shopping complexes or large banking business.



True Enterprise M6 NVR

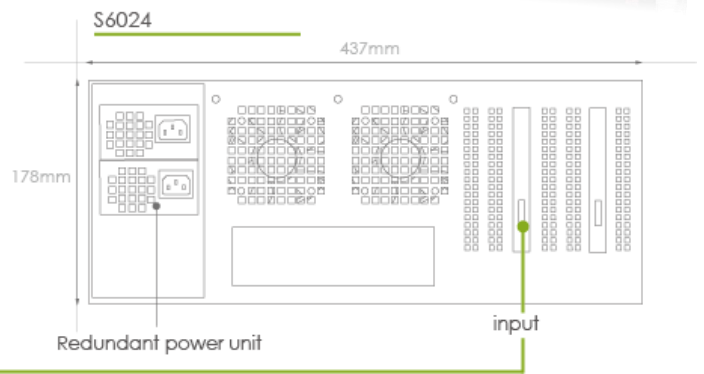
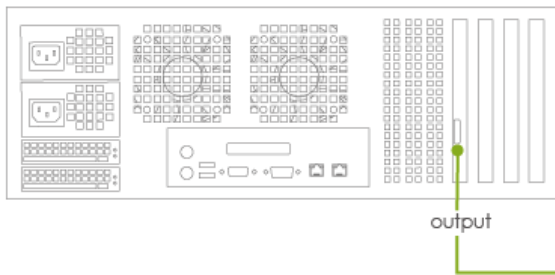

Product	S6044	S6024	
DESCRIPTION	Extended Storage Server (DAS Server)		
STORAGE	Interface	3.5" SATA HDD	
	Hard disk trays (bays)	44 pcs	24 pcs
	Storage capacity	44 x 20TB	24 x 20TB
	RAID level	Depending on the host	
POWER	Voltage	100~240 Vac, 50-60Hz	
	Redundancy	Yes	
	Avg. consumption	120W	98W
ENVIRONMENT	Operating temp.	5°C~35°C (41°F~95°F)	
	Storage temp.	-40°C~70°C (-40°F~158°F)	
	Operating humidity	8%~90% (non-condensing)	
	Storage humidity	5%~95% (non-condensing)	
MECHANIC	Chassis	4U rackmountable chassis	
	Certification	CE & FCC	
	Dimensions (W)x(H)x(D)	437 x 178 x 699 mm	437 x 178 x 660 mm
	Net weight w/o HDD	43.09 kg	34 kg